

A9002297 White (RAL9002)
 LED module: 34.8W 4864lm 4000K neutral white
 On-board Dim
 Version 1
 Construction size L
 Spherulit lens, extra wide flood

Product description
 Cylindrical light head: cast aluminium, powder-coated. 270° tilt.
 Housing: polymer, rotatable on adapter through 360°.
 3-phase adapter for ERCO 220-240V track: polymer, white.
 ERCO control gear. Rotary control for brightness regulation.
 LED module: high-power LEDs.
 Collimating lens made of optical polymer.
 Lens unit: polymer, white. Spherulit lens made of optical polymer.
 Install the luminaire out of people's normal reach.
 Safety class II
 Weight 1.50kg

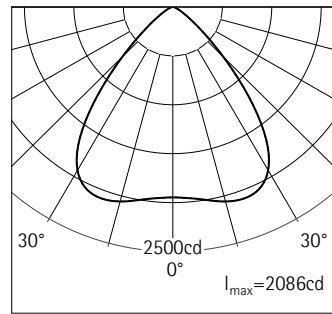

h(m)	E(lx)	D(m)
		82.4°
1.0	1947	1.75
2.0	487	3.50
3.0	216	5.25
4.0	122	7.00
5.0	78	8.75

Technical data

Luminous flux of the luminaire	3570lm
Connected load	38.0W
Luminaire efficacy	94lm/W
Colour deviation	1.5 SDCM
Colour rendition index	CRI 92
Lumen maintenance	L90/B10 >50000h L90 >100000h
LED failure rate	0.1% >50000h
Dimming range	1%-100%
Dimming method	CCR
TLA (Temporal Light Artefacts)	SVM ≤ 0.1; PstLM ≤ 1
LMF	E
Standby power per control gear	--
Luminaires per circuit breaker B16	83

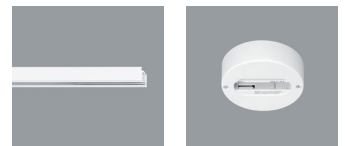

Mounting
 ERCO 3-circuit track
 Hi-trac 3-circuit track
 1-circuit singlet

For your regional contact in the ERCO
 Sales network [click here](http://www.ercosales.com)
www.ercosales.com/contact

Technical Region: 220-240V 50/60Hz
 We reserve the right to make technical and design changes.
 Edition: 28.04.2026
 Current version under
www.ercosales.com/A9002297

Planning data

Melanopic light effect

Art. no.	Spectrum	MR	MDER
A9002297 (direct)	4000K CRI 92	0.71	0.65

MR Melanopic factor (of luminous radiation) $a_{mel,v}$
 MDER Melanopic Daylight Efficacy Ratio $[\gamma]_{mel,v,D65}$

Multiplying the illuminance with the melanopic daylight efficacy ratio MDER gives the melanopic equivalent daylight illuminance MEDI. (MEDI Melanopic Equivalent Daylight Illuminance $[lx] E_{v, mel, D65} [lx]$).

Extract from the Environmental Product Declaration (EPD)

The entire EPD can be found at: www.ercos.com/A9002297

Extrapolation coefficients to convert the reference data from the EPD document for the declared unit

Lighting output	Manufacturing	Distribution	Installation	Use	EoL	Benefits and loads
4437	1	0.999	1.005	1.372	0.999	1

Frequently used EPD data that have already been converted for this article number.

Parameter	Unit	A1-A3	A4	A5	B6	C1	C2	C3	C4	D	Total
Results per functional unit											
GWP	kg CO2 eq	1.13E00	1.97E-02	3.64E-02	5.32E01	0.00E00	5.79E-04	4.93E-02	5.19E-04	-2.92E-02	5.44E01
GWP-biogenic	kg CO2 eq	-3.47E-02	0.00E00	3.49E-02	0.00E00	0.00E00	0.00E00	0.00E00	0.00E00	0.00E00	2.00E-04
Results per declared unit											
GWP	kg CO2 eq	1.46E01	2.56E-01	4.70E-01	6.86E02	0.00E00	7.49E-03	6.38E-01	6.72E-03	-3.79E-01	7.02E02
GWP-biogenic	kg CO2 eq	-4.50E-01	0.00E00	4.52E-01	0.00E00	0.00E00	0.00E00	0.00E00	0.00E00	0.00E00	2.00E-03

A1-A3 Manufacturing
 A4 Distribution
 A5 Installation
 B6 Use
 C1-C4 End of Life
 D Benefits and loads

The data for operating the light (Use B6) refer to the European power source mix. You will find the ERCO EPD Help under Downloads/General planning data.

Cleaning (a)	1				2				3			
	P	C	N	D	P	C	N	D	P	C	N	D
Ambient conditions												
LMF	0.96	0.94	0.90	0.86	0.93	0.91	0.86	0.81	0.92	0.90	0.84	0.79

Hours of operation (h)	1000	5000	10000	20000	30000	40000	50000
LLMF	1.00	0.99	0.98	0.96	0.94	0.92	0.90
LSF	1	1	1	1	1	1	1

MF LMFxRSMFxLLMFxLSF
 MF Maintenance Factor
 LMF Luminaire Maintenance Factor
 RSMF Room Surface Maintenance Factor
 LLMF Lamp Lumens Maintenance Factor
 LSF Lamp Survival Factor
 P Room pure
 C Room clean
 N Room normal
 D Room dirty

Data according to regulations

2019/2020/EU supplemented by 2021/341/EU and 2019/2015/EU supplemented by 2021/340/EU Energy Consumption Labelling Ordinance

This product contains a light source of efficiency class D
 Due to thermal and photometric properties as well as to protect electronic components from ESD (electrostatic discharge) the light source cannot be changed by the customer.

ID EPREL: 1784541
 Model identifier: 3000068434
 Download data sheets for control gear and disassembly instructions at www.ercos.com/slr

Planning data

Technical data in accordance with international norms and standards

IEC 60598	Luminaires – Part 1+2: general requirements, specific requirements and tests
IEC 62031	LED modules for general lighting – safety requirements
IEC 62471	Photobiological safety of lamps and lamp systems
EN 13032-4	Light and lighting – measurement and representation of photometric data
CIE 13	Method of measuring and specifying colour rendering properties of light sources

All technical data is subject to industry-standard tolerances.
Also see www.erco.com/erco-led

For explanations of the symbols and abbreviations used and other general information, see www.erco.com/symbols

Accessories



AC002145
 Lens unit spot
 Polymer, white, rotatable through 360°. Replacement without tools.
 Spherolit lens made of optical polymer.
 Weight 0.10kg
CE



AC002133
 Lens unit extra wide flood
 Polymer, white, rotatable through 360°. Replacement without tools.
 Spherolit lens made of optical polymer.
 Weight 0.10kg
CE



AC002176
 Lens unit spot
 Polymer, black, rotatable through 360°. Replacement without tools.
 Spherolit lens made of optical polymer.
 Weight 0.10kg
CE



AC002164
 Lens unit extra wide flood
 Polymer, black, rotatable through 360°. Replacement without tools.
 Spherolit lens made of optical polymer.
 Weight 0.10kg
CE



AC002138
 Lens unit flood
 Polymer, white, rotatable through 360°. Replacement without tools.
 Spherolit lens made of optical polymer.
 Weight 0.10kg
CE



AC002134
 Lens unit oval flood
 Polymer, white, rotatable through 360°. Replacement without tools.
 Anti-reflective Spherolit lens made of optical polymer.
 Weight 0.10kg
CE



AC002169
 Lens unit flood
 Polymer, black, rotatable through 360°. Replacement without tools.
 Spherolit lens made of optical polymer.
 Weight 0.10kg
CE



AC002165
 Lens unit oval flood
 Polymer, black, rotatable through 360°. Replacement without tools.
 Anti-reflective Spherolit lens made of optical polymer.
 Weight 0.10kg
CE



AC002136
 Lens unit wide flood
 Polymer, white, rotatable through 360°. Replacement without tools.
 Spherolit lens made of optical polymer.
 Weight 0.10kg
CE



AC002135
 Lens unit wallwash
 Polymer, white, rotatable through 360°. Replacement without tools.
 Anti-reflective Spherolit lens made of optical polymer.
 Weight 0.10kg
CE



AC002167
 Lens unit wide flood
 Polymer, black, rotatable through 360°. Replacement without tools.
 Spherolit lens made of optical polymer.
 Weight 0.10kg
CE



AC002166
 Lens unit wallwash
 Polymer, black, rotatable through 360°. Replacement without tools.
 Anti-reflective Spherolit lens made of optical polymer.
 Weight 0.10kg
CE

Accessories



AC002148
 Lens unit zoom spot
 Polymer, white, rotatable through 360°. Replacement without tools.
 Anti-reflective zoom lens made of optical polymer, infinitely variable focus.
 Weight 0.24kg
CE



AC006035
 Softening lens
 Filter holder: polymer, black, rotatable through 360°. Replacement without tools.
 Weight 0.10kg



AC002179
 Lens unit zoom spot
 Polymer, black, rotatable through 360°. Replacement without tools.
 Anti-reflective zoom lens made of optical polymer, infinitely variable focus.
 Weight 0.24kg
CE



AC006043
 Sculpture lens
 Filter holder: polymer, black, rotatable through 360°. Replacement without tools.
 Weight 0.10kg



AC002255
 Lens unit narrow framing
 Aluminium/polymer, coated black, pivotable through 360°. Replacement without tools.
 Projection lens, continuously focusable. Ideal for long projection distances.
 Framing attachment: stainless steel, black.
 Aperture.
 Weight 0.64kg
CE

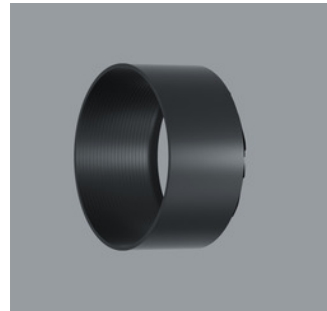

AC001014
 Snoot
 Polymer, black.
 Weight 0.14kg



AC002256
 Lens unit narrow framing
 Aluminium/polymer, coated white, pivotable through 360°. Replacement without tools.
 Projection lens, continuously focusable. Ideal for long projection distances.
 Framing attachment: stainless steel, black.
 Aperture.
 Weight 0.64kg
CE

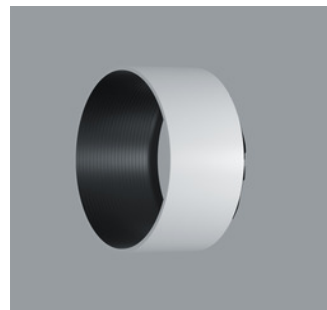

AC001016
 Snoot
 Polymer, black, coated white on outside.
 Weight 0.14kg



AC002259
 Lens unit wide framing
 Aluminium/polymer, coated white, pivotable through 360°. Replacement without tools.
 2 projection lenses, continuously focusable. Ideal for short projection distances.
 Framing attachment: stainless steel, black.
 Aperture.
 Weight 0.64kg
CE

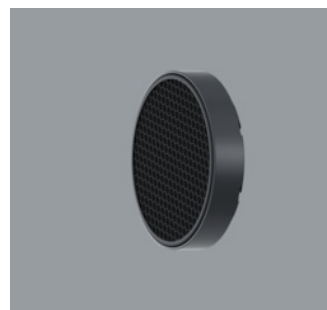

AC004026
 Honeycomb anti-glare screen
 Aluminium, powder-coated black, polymer outer.
 Weight 0.07kg



AC002264
 Lens unit wide framing
 Aluminium/polymer, coated black, pivotable through 360°. Replacement without tools.
 2 projection lenses, continuously focusable. Ideal for short projection distances.
 Framing attachment: stainless steel, black.
 Aperture.
 Weight 0.64kg
CE

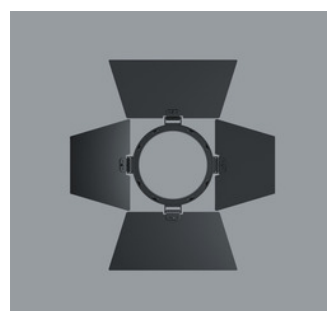

AC005005
 Barn doors 4-fold
 Aluminium, coated black.
 Weight 0.19kg

Accessories

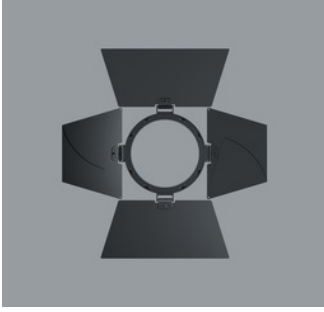

AC005007
Barn doors 8-fold
Aluminium, coated black.
Weight 0.24kg